

Cobalt Series

Underwater Connectors and Cables



Features

- Compact, high-quality system of dry-mate underwater connectors and cables
- Stocked and ready to ship in 2-3 days
- Ideal for autonomous vehicles, underwater instruments, and other extreme-environment applications
- Submersible up to 600 meters
- Compatible with Blue Robotics ROV enclosures, thrusters, grippers, and lights
- Corrosion-resistant, durable 316 stainless steel, PEEK, and polyurethane materials
- Cables available with connectors on both ends or one end only, locking sleeves included
- 3-pin, 12-amp version for servo applications
- 3-pin, 20-amp version for power applications
- 4-pin, 20-amp version for power applications
- 6-pin version for general data applications
- 6-pin hybrid version for combined power and data applications
- 8-pin version with Cat 5e twisted pairs for Ethernet applications

Description

Cobalt Series dry-mate underwater connectors and cables from Blue Trail Engineering set a new standard for small waterproof connectors. Cobalt connectors offer the same reliability as larger subsea connectors, but at a fraction of the cost. With 316 stainless steel shells and PEEK inserts, they withstand long-term use in seawater at depths up to 600 meters. In spite of their compact size, Cobalt connectors can handle high currents. Connector shells are keyed and feature a scoop-proof design, allowing them to be mated blind with no possibility of pin damage.

Advantages

Cost

Cobalt connectors achieve a hermetic seal without the need for potting or overmolding, making them more affordable than traditional molded connectors. The electrical contacts are pressed into a machined PEEK insert, which is in turn pressed into the stainless steel connector shell. To seal the cable jacket to the connector shell, Cobalt Series cables utilize a simple, robust mechanical seal instead of a costly overmolded connection.

Reliability

In addition to reducing cost, the unique design of Cobalt connectors increases their reliability. Without a bonded rubber overmold, there is no danger of leakage due to cathodic delamination. A simple, proven O-ring seal between the male and female connectors makes Cobalt connectors both easier to use and more reliable than wet-mate connectors.

Size

Perfect for space-limited applications, Cobalt connectors take up a fraction of the volume of the industry-standard Micro-Circular connectors.

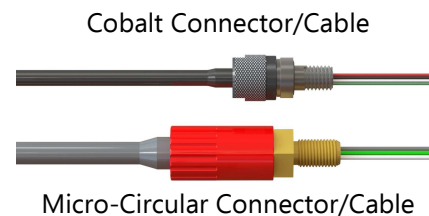

Availability

Stock connectors and cables typically ship in 2-3 days. Custom items or large orders ship in 1-2 weeks.

Options

Cobalt bulkhead connectors and cables are available in 3, 4, 6, and 8-pin versions, suitable for data, power, or hybrid applications.

Cables are supplied with a standard cable length of 1 meter or custom lengths up to 2 meters. Various end termination configurations are available:

- Both ends terminated with Cobalt connectors
- One end terminated with a Cobalt connector, the other end unterminated
- One end terminated with a Cobalt connector, the other end terminated with Blue Trail Engineering Simple Penetrator

Bulkhead connectors have male pins and cables typically have female sockets. However, cables are also available with male pins for making an inline connection between two cables.

For users who wish to install a Cobalt connector on their own cable, Blue Trail Engineering offers Cobalt Series Termination Kits. These kits include a connector shell, PEEK insert with pre-installed sockets, and locking sleeve. The user solders the cable wires to the insert, presses the

insert into the connector shell, and pots the back of the connector shell with epoxy (unlike standard Cobalt cables, the Termination Kits *do* require a potting operation).

Compatibility

The Cobalt bulkhead connector fits in the same 10-mm hole as Blue Robotics penetrators, making quick-connect and quick-disconnect possible with Blue Robotics thrusters, tethers, enclosures, lights, grippers, and other accessories. Cable termination kits allow the user to retrofit existing cables, including Blue Robotics thruster and tether cables, with a Cobalt connector.

Custom Products

Contact Blue Trail Engineering for custom needs, such as:

- USB-compatible cables
- single-pin, high-current cables
- installation of Cobalt connectors on customer-supplied cables.
- custom cable jacket colors

Specifications

Environmental	
Depth Rating	600 meters
Operating Temperature	0° C to +50° C
Electrical	
Maximum voltage	100 VRMS / 150 VDC
Rated current	3-pin: 12 amps 3-pin Power: 20 amps 4-pin: 20 amps 6-pin: 5 amps 6-pin Hybrid: 2x20 amps, 4x0.5 amps 8-pin: 0.5 amps
Wire size and stranding	3-pin: 18 AWG, 19/30 3-pin Power: 16 AWG, 19/29 4-pin: 16 AWG, 19/29 6-pin: 22 AWG, 19/34 6-pin Hybrid: 2x 16 AWG, 19/29; 4x 24 AWG, 7/32 8-pin: 24 AWG, 7/32
Wire configuration	3-pin, 3-pin Power, 4-pin, and 6-pin: unshielded, untwisted 6-pin Hybrid: 2x unshielded, untwisted; 2x unshielded twisted pairs 8-pin: 4x unshielded twisted pairs, Cat 5e
Materials	
Bulkhead connector shell	316 stainless steel
Bulkhead connector insert	PEEK
Bulkhead connector pins	gold-plated brass
Cable connector shell	316 stainless steel
Cable connector insert	PEEK
Cable sockets	gold-plated brass
Cable jacket	95A UV-stabilized polyurethane
wire insulation	3-pin, 3-pin Power, 4-pin, and 6-pin: ETFE 6-pin Hybrid: ETFE, polyolefin 8-pin: polyolefin
O ring	nitrile
Locking sleeve	acetal
Dimensions	
Bulkhead connector threads	M10 X 1.5
Bulkhead connector hex	16 mm
Locking sleeve threads	M16 X 1.5
Cable outer diameter	3-pin: 6.4 mm 3-pin Power: 6.4 mm 4-pin: 8.0 mm 6-pin: 6.4 mm 6-pin Hybrid: 8.0 mm 8-pin: 8.0 mm

Dimensions*

Cable and bulkhead dimensions

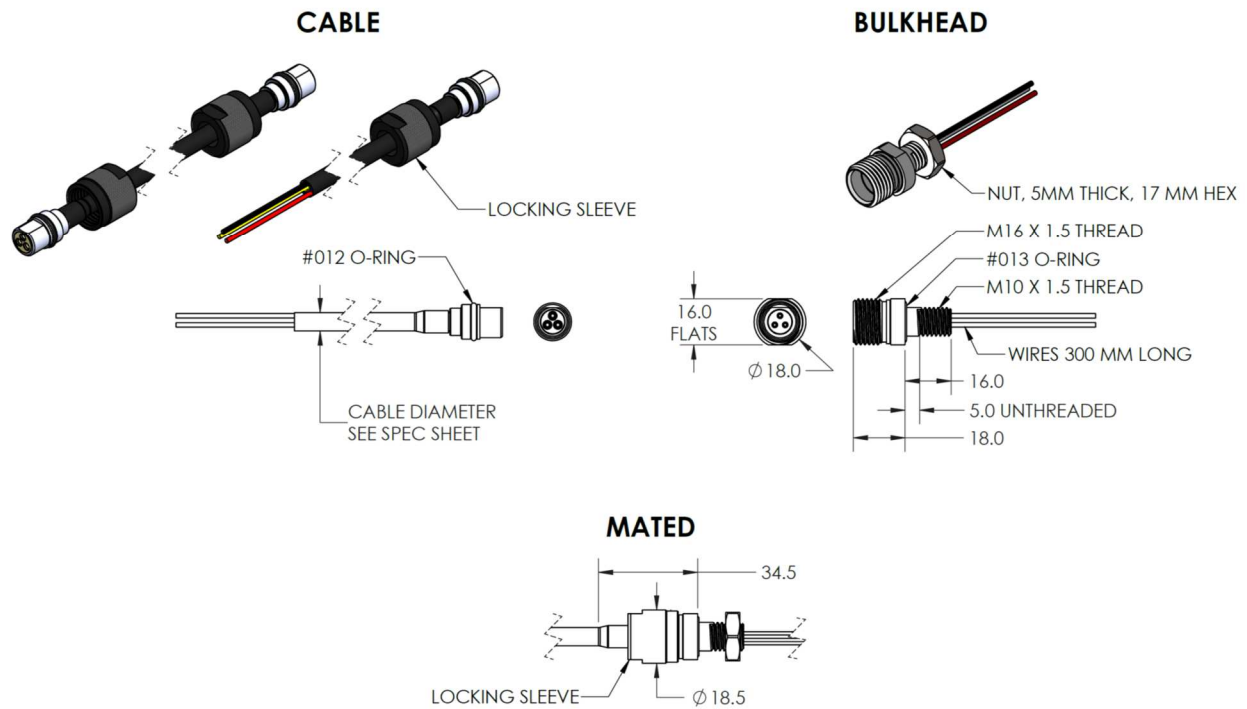

Cable termination kit dimensions

CABLE TERMINATION KIT, REGULAR (CABLE NOT INCLUDED)

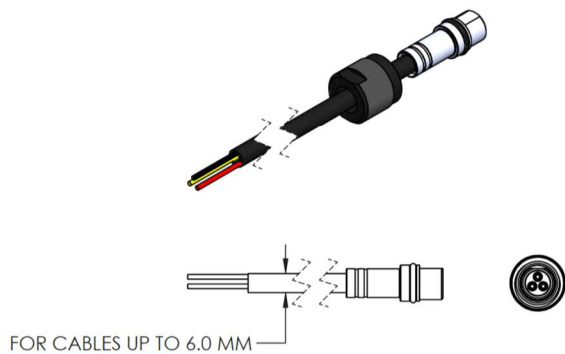

CABLE TERMINATION KIT, LARGE (CABLE NOT INCLUDED)

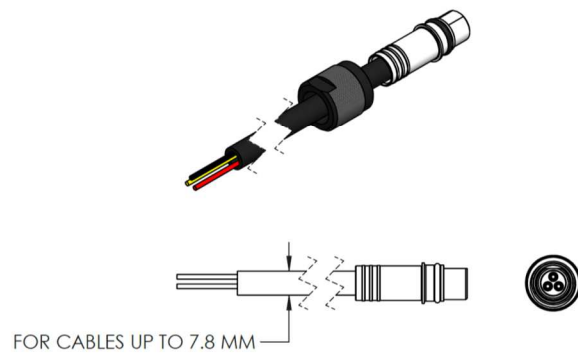

*Contact Blue Trail Engineering for CAD models

Pinouts



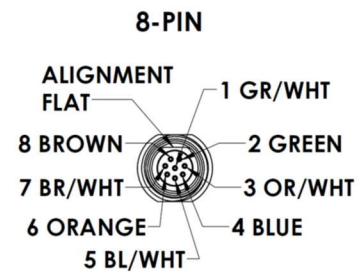
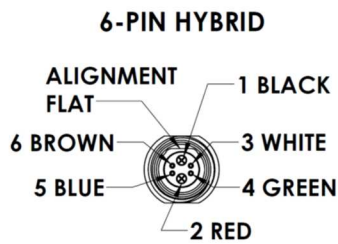
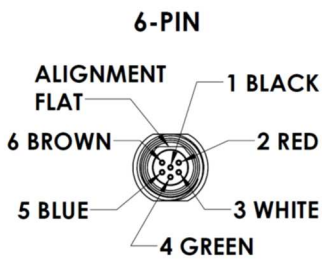
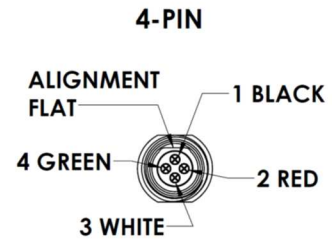
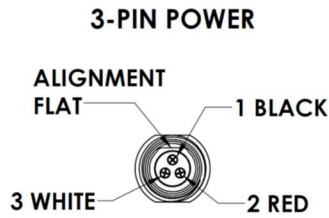
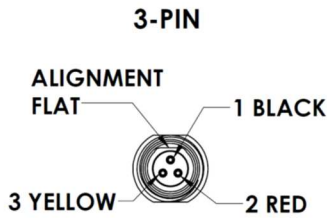

Bulkhead connector pinouts (looking at mating face of connector)

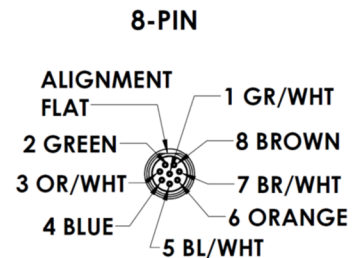
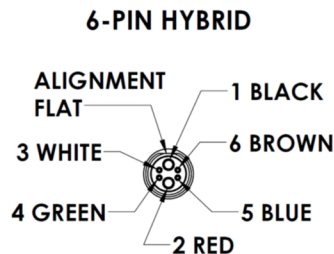
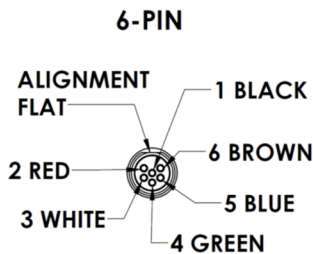
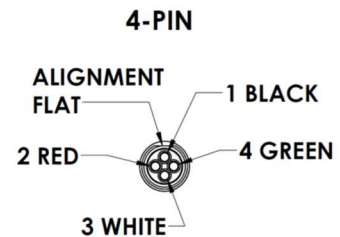
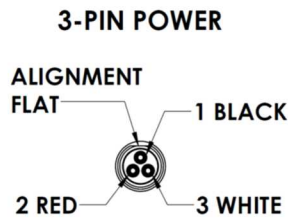
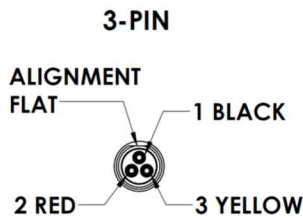



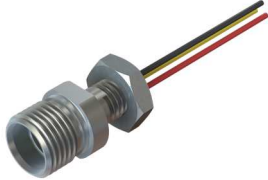

Cable connector pinouts (looking at mating face of connector)



Configurations and Part Numbers

<p>Bulkhead Connector: COB-11<u>N</u>0 <u>N</u>: number of pins (3, 3P, 4, 6, 6H, or 8)</p> 	<ul style="list-style-type: none"> • Corrosion-resistant 316 stainless steel bulkhead connector • Partially threaded M10 X 1.5 • Includes stainless steel nut
<p>Single-ended Cable: COB-12<u>N</u>L <u>N</u>: number of pins (3, 3P, 4, 6, 6H, or 8) <u>L</u>: cable length (1=1m, C=Custom)</p> 	<ul style="list-style-type: none"> • Single-ended cable compatible with Cobalt bulkhead connector • Corrosion-free 316 stainless steel connector shell and acetal locking sleeve • Unterminated end of polyurethane cable can be bonded or potted with urethane adhesives • Standard 1-meter or custom length
<p>Double-ended Cable: COB-13<u>N</u>L <u>N</u>: number of pins (3, 3P, 4, 6, 6H, or 8) <u>L</u>: cable length (1=1m, C=Custom)</p> 	<ul style="list-style-type: none"> • Double-ended cable compatible with Cobalt bulkhead connectors • Corrosion-free 316 stainless steel connector bodies and acetal locking sleeves • Standard 1-meter or custom length
<p>Cable with Simple Penetrator: COB-1<u>P</u><u>N</u>L <u>P</u>: Simple Penetrator type (4: M6*, 5: M10) <u>N</u>: number of pins (3, 3P, 4, 6, 6H, or 8) <u>L</u>: cable length (1=1m, C=Custom) *M6 Simple Penetrator only available on 3-pin and 6-pin cables</p> 	<ul style="list-style-type: none"> • 1-meter cable compatible with Cobalt bulkhead connector on one end, with M6 or M10 Simple Penetrator on other end • Standard 1-meter or custom length



<p>Single-ended Cable with Male Pins: COB-16NL N: number of pins (3, 3P, 4, 6, 6H, or 8) L: cable length (1=1m, C=Custom)</p> 	<ul style="list-style-type: none"> • Single-ended cable with male pins and coupler for making inline connection to standard single-ended cable • Pinout same as bulkhead connector • Corrosion-free 316 stainless steel connector shell, acetal coupler and locking sleeve • Unterminated end of polyurethane cable can be bonded or potted with urethane adhesives • Standard 1-meter or custom length
<p style="text-align: center;">Accessories</p> <p>Locking Sleeve: COB-1001 (standard) COB-1004 (removable)</p>  <p>Dummy Plug: COB-1002</p>  <p>Dummy Cap: COB-1003</p>  <p>Coupler: COB-1005</p> 	<ul style="list-style-type: none"> • Locking Sleeve available in standard (captive on cable) or removable versions • Dummy plug seals and protects an unused bulkhead connector • Dummy cap seals and protects an unused cable • Coupler used for making inline connection between two cables

Cable Termination Kit: COB-31NS

N: number of pins (3, 3P, 4, 6, 6H, or 8)

S: connector shell size (0=regular, 1=large)



- Used to terminate an existing cable with a Cobalt connector
- Requires potting connector shell with epoxy
- Corrosion-free 316 stainless steel connector shell, PEEK insert with pre-installed sockets, and acetal locking sleeve
- Regular or large sizes